

# TSR-3296 & 3266



## 玻璃釉微調電位器

- 多圈的/金屬陶瓷/工業用/密封
- (Multiturn/ Cermet/ Industrial/ Sealed)
- 5種引線的安裝尺寸
- (5 Terminal Styles)

| 電氣特性                                   | Electrical Characteristics |                |
|--|----------------------------|----------------|
|  | TSR-3296                   | TSR-3266       |
| 標稱阻值範圍<br>Standard Resistance Range    | 10Ω - 5MΩ                  | 10Ω - 5MΩ      |
| 阻值允許偏差<br>Resistance Tolerance         | ±10%                       | ±10%           |
| 終端電阻<br>Absolute Minimum Resistance    | ≤1% R 或 10n                | ≤1% R 或 10Ω    |
| 接觸電阻變化<br>Contact Resistance Variation | CRV≤3%或 5n                 | CRV≤3%或 5Ω     |
| 絕緣電阻<br>Insulation Resistance          | R1≥1GΩ(100Vac)             | R1≥1GΩ(100Vac) |
| 耐電壓<br>Withstand Voltage               | 640Vac                     | 500Vac         |
| 有效行程<br>Effective Travel               | 30±2 turns nom             | 12±2 turns nom |

| 環境特性                                     | Environmental Characteristics   |   |
|--|---|---|
|  | TSR-3296  | TSR-3266  |
| 額定功率<br>Power Rating<br>(315Volts max)   | 0.5W@70°C, 0W@125°C   | 0.25W@70°C, 0W@125°C  |
| 溫度範圍<br>Temperature Range                | -55°C ~ +125°C  | -55°C ~ +125°C  |
| 溫度係數<br>Temperature Coefficient          | General offer ±250 ppm/°C<br>(±100ppm/°C is available if request.)    | General offer ±250 ppm/°C<br>(±100ppm/°C is available if request.)    |
| 溫度變化<br>Temperature Variation            | -55°C, 30min, +125°C<br>30min, 循環5次 5 cycles<br>ΔR≤5%R, Δ(Uab/Uac)≤5% | -55°C, 30min, +125°C<br>30min, 循環5次 5 cycles<br>ΔR≤5%R, Δ(Uab/Uac)≤5% |
| 振動<br>Vibration                          | 10 - 500Hz, 0.75mm, 6h<br>ΔR≤5%R, Δ(Uab/Uac)≤7.5%                     | 10 - 500Hz, 0.75mm, 6h<br>ΔR≤5%R, Δ(Uab/Uac)≤7.5%                     |
| 碰撞<br>Collision                          | 390m/s <sup>2</sup> , 4000cycles, ΔR≤5%R                              | 390m/s <sup>2</sup> , 4000cycles, ΔR≤5%R                              |
| 70°C 耐久性<br>Electrical Endurance at 70°C | 0.5W@70°C<br>1000h, ΔR≤10%R<br>CRV≤3% or 5Ω                           | 0.25W@70°C<br>1000h, ΔR≤10%R<br>CRV≤3% or 5Ω                          |
| 機械壽命<br>Rotational Life                  | 200 周 (200 cycles)<br>ΔTR≤10%R, CRV≤3% or 5n                          | 200 周 (200 cycles)<br>ΔR≤10%R, CRV≤3% or 5Ω                           |

### TSR-3296

共有尺寸 Common Dimensions

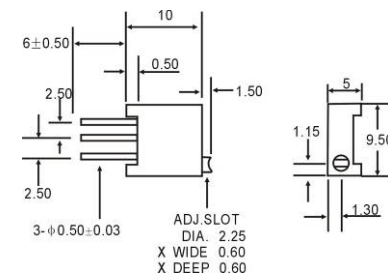

### TSR-3296P

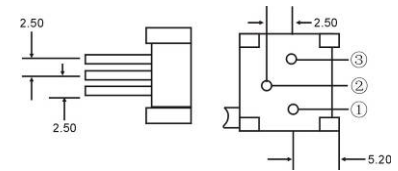

### TSR-3296X

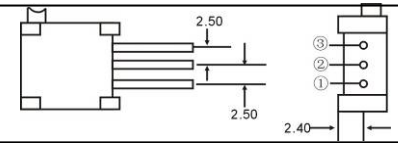

### TSR-3296Z

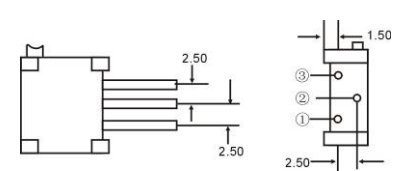

### TSR-3296W

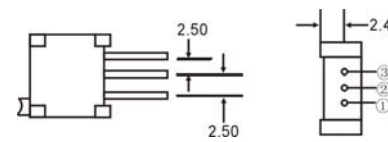

### TSR-3296Y

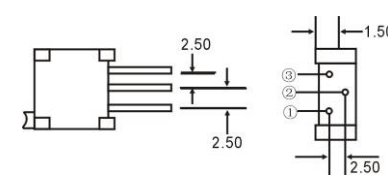

### TSR-3266

共有尺寸 Common Dimensions

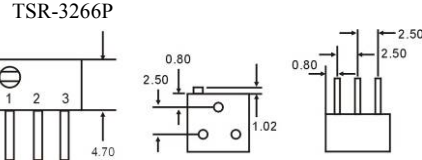

### TSR-3266W

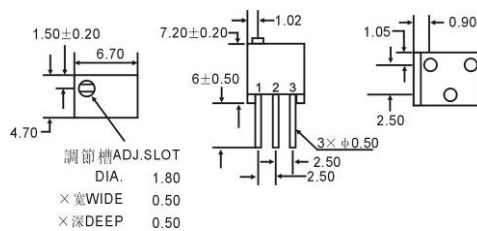

### TSR-3266X

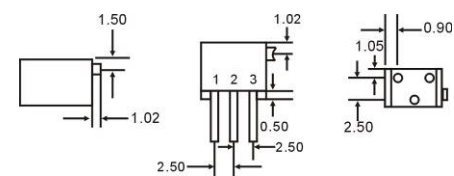

### TSR-3266Z

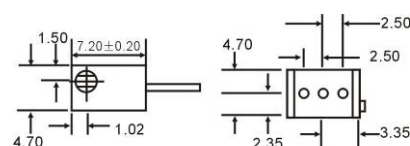

### TSR-3266Y

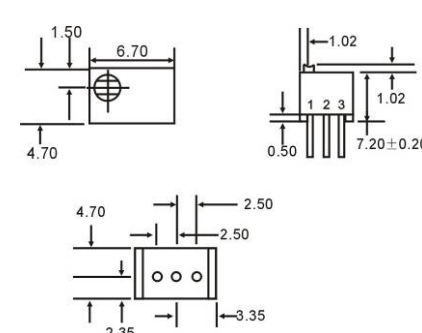

### 阻值代碼表 Standard Resistance table

| Resistance(Ohms) | Resistance Code |
|------------------|-----------------|
| 10               | 100             |
| 20               | 200             |
| 50               | 500             |
| 100              | 101             |
| 150              | 151             |
| 200              | 201             |
| 250              | 251             |
| 300              | 301             |
| 470              | 471             |
| 500              | 501             |
| 680              | 681             |
| 1,000            | 102             |
| 1,500            | 152             |
| 2,000            | 202             |
| 2,200            | 222             |
| 2,500            | 252             |
| 3,000            | 302             |
| 4,700            | 472             |
| 5,000            | 502             |
| 6,800            | 682             |
| 10,000           | 103             |
| 15,000           | 153             |
| 20,000           | 203             |
| 22,000           | 223             |
| 25,000           | 253             |
| 30,000           | 303             |
| 33,000           | 333             |
| 47,000           | 473             |
| 50,000           | 503             |
| 68,000           | 683             |
| 100,000          | 104             |
| 150,000          | 154             |
| 200,000          | 204             |
| 220,000          | 224             |
| 250,000          | 254             |
| 300,000          | 304             |
| 330,000          | 334             |
| 470,000          | 474             |
| 500,000          | 504             |
| 680,000          | 684             |
| 1,000,000        | 105             |
| 2,000,000        | 205             |
| 2,200,000        | 225             |
| 5,000,000        | 505             |

### 訂購指南 How to Order

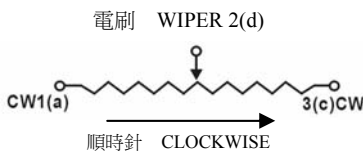
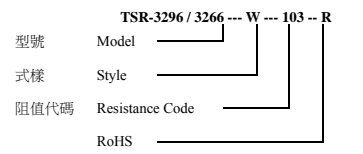

圖中公差：除注明外均為±0.25  
Tolerance is ±0.25 if no identification

| 物理特性                       | Physical Characteristics   |
|----------------------------|--|
| 起動力矩<br>Starting Torque    | ≤35mN·m  |
| 標誌<br>Marking              | 阻值允許偏差(±10%不標注)<br>阻值代碼產品型號<br>Resistance Tolerance<br>Resistance Code, Model<br>(When no identification, it is of ±10%) |
| 標準包裝<br>Standard Packaging | 50 只/管<br>(50pcs, per tube)  |

可按用戶要求提供特殊規格  
Special resistances available.

Note: Specification are subject to change without notice. For more detail and update, please visit our website.